

J801

GATE OUTPUTS

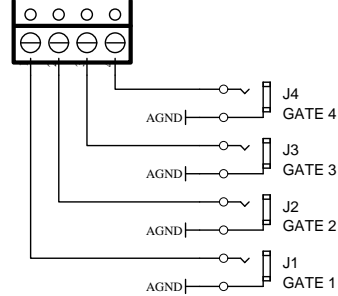

J701

CC OUTPUTS

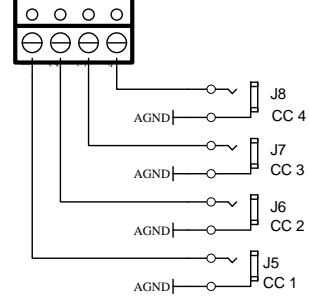

J711  
VELOCITY OUTPUTS

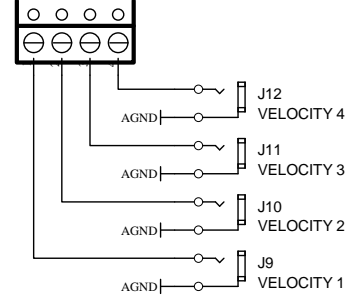

J601  
NOTE OUTPUTS

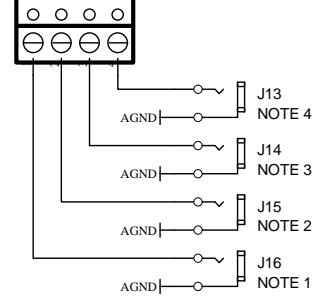

J501

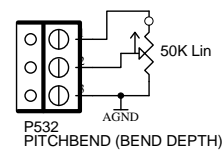
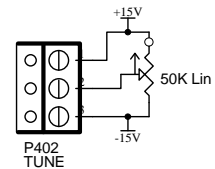
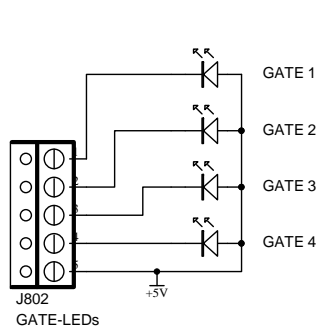
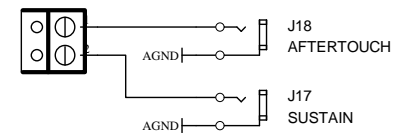

J531  
PITCHBEND-CV

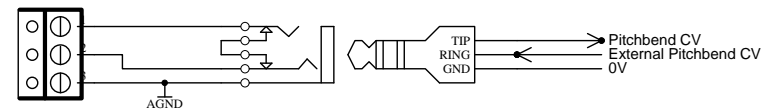

P501  
MODWHEEL

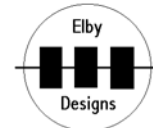
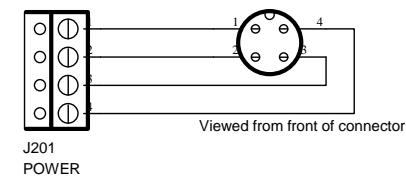
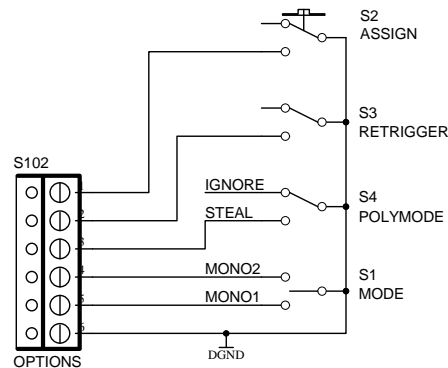
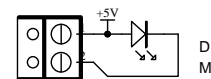
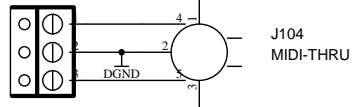
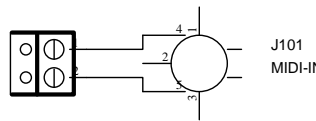
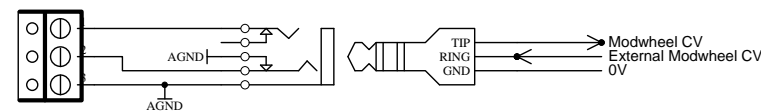

9 Follan Close  
Kariang  
NSW 2250  
Australia

PolyDAC (X) 4-Channel MIDI-CV  
Reproduced with permission from Paul Maddox

Panel Wiring Details

Size A3	FCSM No. 20/11/2013	DWG No. panel-wiring.schdoc	Rev 2
Scale	Laurie Biddulph		Sheet 0 of 0